

4GB DDR3 SDRAM SO-DIMM**EBJ41UF8BAS0 (512M words × 64 bits, 2 Ranks)****Specifications**

- Density: 4GB
- Organization
 - 512M words × 64 bits, 2 ranks
- Mounting 16 pieces of 2G bits DDR3 SDRAM sealed in FBGA
- Package: 204-pin socket type small outline dual in line memory module (SO-DIMM)
 - PCB height: 30.0mm
 - Lead pitch: 0.6mm
 - Lead-free (RoHS compliant) and Halogen-free
- Power supply: VDD = 1.5V ± 0.075V
- Data rate: 1600Mbps/1333Mbps/1066Mbps (max.)
- Eight internal banks for concurrent operation (components)
- Interface: SSTL_15
- Burst lengths (BL): 8 and 4 with Burst Chop (BC)
- /CAS Latency (CL): 6, 7, 8, 9, 10, 11
- /CAS write latency (CWL): 5, 6, 7, 8
- Precharge: auto precharge option for each burst access
- Refresh: auto-refresh, self-refresh
- Refresh cycles
 - Average refresh period
 - 7.8μs at 0°C ≤ TC ≤ +85°C
 - 3.9μs at +85°C < TC ≤ +95°C
- Operating case temperature range
 - TC = 0°C to +95°C

Features

- Double-data-rate architecture; two data transfers per clock cycle
- The high-speed data transfer is realized by the 8 bits prefetch pipelined architecture
- Bi-directional differential data strobe (DQS and /DQS) is transmitted/received with data for capturing data at the receiver
- DQS is edge-aligned with data for READs; center-aligned with data for WRITEs
- Differential clock inputs (CK and /CK)
- DLL aligns DQ and DQS transitions with CK transitions
- Commands entered on each positive CK edge; data and data mask referenced to both edges of DQS
- Data mask (DM) for write data
- Posted /CAS by programmable additive latency for better command and data bus efficiency
- On-Die-Termination (ODT) for better signal quality
 - Synchronous ODT
 - Dynamic ODT
 - Asynchronous ODT
- Multi Purpose Register (MPR) for temperature read out
- ZQ calibration for DQ drive and ODT
- Programmable Partial Array Self-Refresh (PASR)
- /RESET pin for Power-up sequence and reset function
- SRT range:
 - Normal/extended
- Programmable Output driver impedance control

Ordering Information

Part number	Data rate Mbps (max.)	Component JEDEC speed bin (CL-tRCD-tRP)	Package	Contact pad	Mounted devices
EBJ41UF8BAS0-GN-F	1600	DDR3-1600K (11-11-11)	204-pin SO-DIMM (lead-free and halogen-free)	Gold	EDJ2108BASE-GN-F
EBJ41UF8BAS0-DJ-F	1333	DDR3-1333H (9-9-9)			EDJ2108BASE-GN-F EDJ2108BASE-DJ-F
EBJ41UF8BAS0-AE-F	1066	DDR3-1066F (7-7-7)			EDJ2108BASE-GN-F EDJ2108BASE-DJ-F EDJ2108BASE-AE-F

Pin Configurations

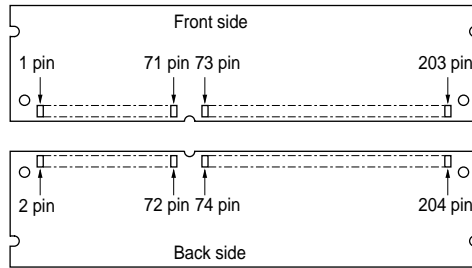

Front side			Back side				
Pin No.	Pin name	Pin No.	Pin name	Pin No.	Pin name	Pin No.	Pin name
1	VREFDQ	103	/CK0	2	VSS	104	/CK1
3	VSS	105	VDD	4	DQ4	106	VDD
5	DQ0	107	A10 (AP)	6	DQ5	108	BA1
7	DQ1	109	BA0	8	VSS	110	/RAS
9	VSS	111	VDD	10	/DQS0	112	VDD
11	DM0	113	/WE	12	DQS0	114	/CS0
13	VSS	115	/CAS	14	VSS	116	ODT0
15	DQ2	117	VDD	16	DQ6	118	VDD
17	DQ3	119	A13	18	DQ7	120	ODT1
19	VSS	121	/CS1	20	VSS	122	NC
21	DQ8	123	VDD	22	DQ12	124	VDD
23	DQ9	125	NC	24	DQ13	126	VREFCA
25	VSS	127	VSS	26	VSS	128	VSS
27	/DQS1	129	DQ32	28	DM1	130	DQ36
29	DQS1	131	DQ33	30	/RESET	132	DQ37
31	VSS	133	VSS	32	VSS	134	VSS
33	DQ10	135	/DQS4	34	DQ14	136	DM4
35	DQ11	137	DQS4	36	DQ15	138	VSS
37	VSS	139	VSS	38	VSS	140	DQ38
39	DQ16	141	DQ34	40	DQ20	142	DQ39
41	DQ17	143	DQ35	42	DQ21	144	VSS
43	VSS	145	VSS	44	VSS	146	DQ44
45	/DQS2	147	DQ40	46	DM2	148	DQ45
47	DQS2	149	DQ41	48	VSS	150	VSS
49	VSS	151	VSS	50	DQ22	152	/DQS5
51	DQ18	153	DM5	52	DQ23	154	DQS5
53	DQ19	155	VSS	54	VSS	156	VSS
55	VSS	157	DQ42	56	DQ28	158	DQ46
57	DQ24	159	DQ43	58	DQ29	160	DQ47
59	DQ25	161	VSS	60	VSS	162	VSS
61	VSS	163	DQ48	62	/DQS3	164	DQ52
63	DM3	165	DQ49	64	DQS3	166	DQ53
65	VSS	167	VSS	66	VSS	168	VSS
67	DQ26	169	/DQS6	68	DQ30	170	DM6

Front side				Back side			
Pin No.	Pin name	Pin No.	Pin name	Pin No.	Pin name	Pin No.	Pin name
69	DQ27	171	DQS6	70	DQ31	172	VSS
71	VSS	173	VSS	72	VSS	174	DQ54
73	CKE0	175	DQ50	74	CKE1	176	DQ55
75	VDD	177	DQ51	76	VDD	178	VSS
77	NC	179	VSS	78	NC	180	DQ60
79	BA2	181	DQ56	80	A14	182	DQ61
81	VDD	183	DQ57	82	VDD	184	VSS
83	A12 (/BC)	185	VSS	84	A11	186	/DQS7
85	A9	187	DM7	86	A7	188	DQS7
87	VDD	189	VSS	88	VDD	190	VSS
89	A8	191	DQ58	90	A6	192	DQ62
91	A5	193	DQ59	92	A4	194	DQ63
93	VDD	195	VSS	94	VDD	196	VSS
95	A3	197	SA0	96	A2	198	NC
97	A1	199	VDDSPD	98	A0	200	SDA
99	VDD	201	SA1	100	VDD	202	SCL
101	CK0	203	VTT	102	CK1	204	VTT

Pin Description

Pin name	Function
	Address input
A0 to A14	Row address A0 to A14 Column address A0 to A9
A10 (AP)	Auto precharge
A12 (/BC)	Burst chop
BA0, BA1, BA2	Bank select address
DQ0 to DQ63	Data input/output
/RAS	Row address strobe command
/CAS	Column address strobe command
/WE	Write enable
/CS0, /CS1	Chip select
CKE0, CKE1	Clock enable
CK0, CK1	Clock input
/CK0, /CK1	Differential clock input
DQS0 to DQS7, /DQS0 to /DQS7	Input and output data strobe
DM0 to DM7	Input mask
SCL	Clock input for serial PD
SDA	Data input/output for serial PD
SA0, SA1	Serial address input
VDD	Power for internal circuit
VDDSPD	Power for serial EEPROM
VREFCA	Reference voltage for CA
VREFDQ	Reference voltage for DQ
VSS	Ground
VTT	I/O termination supply for SDRAM
/RESET	Set DRAM to known state
ODT0, ODT1	ODT control
NC	No connection

Serial PD Matrix

Byte No.	Function described	Bit7	Bit6	Bit5	Bit4	Bit3	Bit2	Bit1	Bit0	Hex value	Comments
0	Number of serial PD bytes written/SPD device size/CRC coverage -GN	0	0	0	0	0	0	0	0	00H	TBD
	-DJ, -AE	1	0	0	1	0	0	1	0	92H	176/256/0-116
1	SPD revision	0	0	0	1	0	0	0	0	10H	Revision 1.0
2	Key byte/DRAM device type	0	0	0	0	1	0	1	1	0BH	DDR3 SDRAM
3	Key byte/module type	0	0	0	0	0	0	1	1	03H	SO-DIMM
4	SDRAM density and banks	0	0	0	0	0	0	1	1	03H	2G bits, 8 banks
5	SDRAM addressing	0	0	0	1	1	0	0	1	19H	15 rows, 10 columns
6	Module nominal voltage, VDD	0	0	0	0	0	0	0	0	00H	1.5V
7	Module organization	0	0	0	0	1	0	0	1	09H	2 ranks/x8 bits
8	Module memory bus width	0	0	0	0	0	0	1	1	03H	64 bits/non-ECC
9	Fine timebase (FTB) dividend/divisor	0	1	0	1	0	0	1	0	52H	5/2
10	Medium timebase (MTB) dividend	0	0	0	0	0	0	0	1	01H	1
11	Medium timebase (MTB) divisor	0	0	0	0	1	0	0	0	08H	8
12	SDRAM minimum cycle time (tCK (min.)) -GN	0	0	0	0	0	0	0	0	00H	TBD
	-DJ	0	0	0	0	1	1	0	0	0CH	1.5ns
	-AE	0	0	0	0	1	1	1	1	0FH	1.875ns
13	Reserved	0	0	0	0	0	0	0	0	00H	—
14	SDRAM /CAS latencies supported, LSB -GN	0	0	0	0	0	0	0	0	00H	TBD
	-DJ	0	0	1	1	1	1	0	0	3CH	CL = 6, 7, 8, 9
	-AE	0	0	0	1	1	1	0	0	1CH	CL = 6, 7, 8
15	SDRAM /CAS latencies supported, MSB	0	0	0	0	0	0	0	0	00H	—
16	SDRAM minimum /CAS latencies time (tAA (min.))	0	1	1	0	1	0	0	1	69H	13.125ns
17	SDRAM write recovery time (tWR (min))	0	1	1	1	1	0	0	0	78H	15ns
18	SDRAM minimum /RAS to /CAS delay (tRCD)	0	1	1	0	1	0	0	1	69H	13.125ns
19	SDRAM minimum row active to row active delay (tRRD) -GN	0	0	0	0	0	0	0	0	00H	TBD
	-DJ	0	0	1	1	0	0	0	0	30H	6ns
	-AE	0	0	1	1	1	1	0	0	3CH	7.5ns
20	SDRAM minimum row precharge time (tRP)	0	1	1	0	1	0	0	1	69H	13.125ns
21	SDRAM upper nibbles for tRAS and tRC	0	0	0	1	0	0	0	1	11H	
22	SDRAM minimum active to precharge time (tRAS), LSB -GN	0	0	0	0	0	0	0	0	00H	TBD
	-DJ	0	0	1	0	0	0	0	0	20H	36ns
	-AE	0	0	1	0	1	1	0	0	2CH	37.5ns

Byte No.	Function described	Bit7	Bit6	Bit5	Bit4	Bit3	Bit2	Bit1	Bit0	Hex value	Comments
23	SDRAM minimum active to active /auto-refresh time (tRC), LSB -GN	0	0	0	0	0	0	0	0	00H	TBD
	-DJ	1	0	0	0	1	0	0	1	89H	49.125ns
	-AE	1	0	0	1	0	1	0	1	95H	50.625ns
24	SDRAM minimum refresh recovery time delay (tRFC), LSB	0	0	0	0	0	0	0	0	00H	160ns
25	SDRAM minimum refresh recovery time delay (tRFC), MSB	0	0	0	0	0	1	0	1	05H	160ns
26	SDRAM minimum internal write to read command delay (tWTR)	0	0	1	1	1	1	0	0	3CH	7.5ns
27	SDRAM minimum internal read to precharge command delay (tRTP)	0	0	1	1	1	1	0	0	3CH	7.5ns
28	Upper nibble for tFAW -GN	0	0	0	0	0	0	0	0	00H	TBD
	-DJ	0	0	0	0	0	0	0	0	00H	30.0ns
	-AE	0	0	0	0	0	0	0	1	01H	37.5ns
29	Minimum four activate window delay time (tFAW) -GN	0	0	0	0	0	0	0	0	00H	TBD
	-DJ	1	1	1	1	0	0	0	0	F0H	30.0ns
	-AE	0	0	1	0	1	1	0	0	2CH	37.5ns
30	SDRAM output drivers supported	1	0	0	0	0	0	1	1	83H	DLL-off/RZQ/6, 7
31	SDRAM refresh options	1	0	0	0	0	0	0	1	81H	PASR/2X refresh at +85C° to +95C°
32	Module thermal sensor	0	0	0	0	0	0	0	0	00H	Not Incorporated
33	SDRAM device type	0	0	0	0	0	0	0	0	00H	Standard
34 to 59	Reserved	0	0	0	0	0	0	0	0	00H	—
60	Module nominal height	0	0	0	0	1	1	1	1	0FH	29 < height ≤ 30mm
61	Module maximum thickness	0	0	0	1	0	0	0	1	11H	
62	Reference raw card used	0	1	0	0	0	1	0	1	45H	Raw Card F2
63	Address mapping from edge connector to DRAM	0	0	0	0	0	0	0	0	00H	Standard
64 to 116	Module specific section	0	0	0	0	0	0	0	0	00H	—
117	Module ID: manufacturer's JEDEC ID code, LSB	0	0	0	0	0	0	1	0	02H	Elpida Memory
118	Module ID: manufacturer's JEDEC ID code, MSB	1	1	1	1	1	1	1	0	FEH	Elpida Memory
119	Module ID: manufacturing location	x	x	x	x	x	x	x	x	xx	
120	Module ID: manufacturing date	x	x	x	x	x	x	x	x	xx	Year code (BCD)
121	Module ID: manufacturing date	x	x	x	x	x	x	x	x	xx	Week code (BCD)
122 to 125	Module ID: module serial number	x	x	x	x	x	x	x	x	xx	
126	Cyclical redundancy code (CRC) -GN	0	0	0	0	0	0	0	0	00H	TBD
	-DJ	0	1	0	0	1	0	0	1	49H	
	-AE	0	0	0	0	1	0	1	1	0BH	

Byte No.	Function described	Bit7	Bit6	Bit5	Bit4	Bit3	Bit2	Bit1	Bit0	Hex value	Comments
127	Cyclical redundancy code (CRC) -GN	0	0	0	0	0	0	0	0	00H	TBD
	-DJ	1	0	0	1	1	0	1	0	9AH	
	-AE	0	0	1	1	0	0	1	1	33H	
128	Module part number	0	1	0	0	0	1	0	1	45H	E
129	Module part number	0	1	0	0	0	0	1	0	42H	B
130	Module part number	0	1	0	0	1	0	1	0	4AH	J
131	Module part number	0	0	1	1	0	1	0	0	34H	4
132	Module part number	0	0	1	1	0	0	0	1	31H	1
133	Module part number	0	1	0	1	0	1	0	1	55H	U
134	Module part number	0	1	0	0	0	1	1	0	46H	F
135	Module part number	0	0	1	1	1	0	0	0	38H	8
136	Module part number	0	1	0	0	0	0	1	0	42H	B
137	Module part number	0	1	0	0	0	0	0	1	41H	A
138	Module part number	0	1	0	1	0	0	1	1	53H	S
139	Module part number	0	0	1	1	0	0	0	0	30H	0
140	Module part number	0	0	1	0	1	1	0	1	2DH	—
141	Module part number -GN	0	1	0	0	0	1	1	1	47H	G
	-DJ	0	1	0	0	0	1	0	0	44H	D
	-AE	0	1	0	0	0	0	0	1	41H	A
142	Module part number -GN	0	1	0	0	1	1	1	0	4EH	N
	-DJ	0	1	0	0	1	0	1	0	4AH	J
	-AE	0	1	0	0	0	1	0	1	45H	E
143	Module part number	0	0	1	0	1	1	0	1	2DH	—
144	Module part number	0	1	0	0	0	1	1	0	46H	F
145	Module part number	0	0	1	0	0	0	0	0	20H	(Space)
146	Module revision code	0	0	1	1	0	0	0	0	30H	Initial
147	Module revision code	0	0	1	0	0	0	0	0	20H	(Space)
148	SDRAM manufacturer's JEDEC ID code, LSB	0	0	0	0	0	0	1	0	02H	Elpida Memory
149	SDRAM manufacturer's JEDEC ID code, MSB	1	1	1	1	1	1	1	0	FEH	Elpida Memory
150 to 175	Manufacturer's specific data										
176 to 254	Intel extreme memory profile -GN	TBD									
	-DJ, -AE	0	0	0	0	0	0	0	0	00H	Not supported
255	Open for customer use										

SPD for Intel Extreme Memory Profile (EBJ41UF8BAS0-GN)

Byte No.	Function described	Bit7	Bit6	Bit5	Bit4	Bit3	Bit2	Bit1	Bit0	Hex value	Comments
176	Intel extreme memory profile ID string	0	0	0	0	0	0	0	0	00H	TBD
177	Intel extreme memory profile ID string	0	0	0	0	0	0	0	0	00H	TBD
178	Intel extreme memory profile organization type	0	0	0	0	0	0	0	0	00H	TBD
179	Intel extreme memory profile revision	0	0	0	0	0	0	0	0	00H	TBD
180	Medium timebase (MTB) dividend for profile 1	0	0	0	0	0	0	0	0	00H	TBD
181	Medium timebase (MTB) divisor for profile 1	0	0	0	0	0	0	0	0	00H	TBD
182	Medium timebase (MTB) dividend for profile 2	0	0	0	0	0	0	0	0	00H	TBD
183	Medium timebase (MTB) divisor for profile 2	0	0	0	0	0	0	0	0	00H	TBD
184	Reserved for global byte	0	0	0	0	0	0	0	0	00H	TBD

[For Profile 1]

Byte No.	Function described	Bit7	Bit6	Bit5	Bit4	Bit3	Bit2	Bit1	Bit0	Hex value	Comments
185	Module VDD voltage level	0	0	0	0	0	0	0	0	00H	TBD
186	SDRAM minimum cycle time (tCK (min.))	0	0	0	0	0	0	0	0	00H	TBD
187	SDRAM minimum /CAS latencies time (tAA (min.))	0	0	0	0	0	0	0	0	00H	TBD
188	SDRAM /CAS latencies supported, LSB (CL MASK)	0	0	0	0	0	0	0	0	00H	TBD
189	SDRAM /CAS latencies supported, MSB (CL MASK)	0	0	0	0	0	0	0	0	00H	TBD
190	Minimum CAS write latency time (tCWL(min))	0	0	0	0	0	0	0	0	00H	TBD
191	SDRAM minimum row precharge time (tRP)	0	0	0	0	0	0	0	0	00H	TBD
192	SDRAM minimum /RAS to /CAS delay (tRCD)	0	0	0	0	0	0	0	0	00H	TBD
193	SDRAM write recovery time (tWR (min))	0	0	0	0	0	0	0	0	00H	TBD
194	SDRAM upper nibbles for tRAS and tRC	0	0	0	0	0	0	0	0	00H	TBD
195	SDRAM minimum active to precharge time (tRAS), LSB	0	0	0	0	0	0	0	0	00H	TBD
196	SDRAM minimum active to active /auto-refresh time (tRC), LSB	0	0	0	0	0	0	0	0	00H	TBD
197	Maximum average periodic refresh interval (tREFI), LSB	0	0	0	0	0	0	0	0	00H	TBD
198	Maximum average periodic refresh interval (tREFI), MSB	0	0	0	0	0	0	0	0	00H	TBD
199	SDRAM minimum refresh recovery time delay (tRFC), LSB	0	0	0	0	0	0	0	0	00H	TBD
200	SDRAM minimum refresh recovery time delay (tRFC), MSB	0	0	0	0	0	0	0	0	00H	TBD
201	SDRAM minimum internal read to precharge command delay (tRTP)	0	0	0	0	0	0	0	0	00H	TBD

Byte No.	Function described	Bit7	Bit6	Bit5	Bit4	Bit3	Bit2	Bit1	Bit0	Hex value	Comments
202	SDRAM minimum row active to row active delay (tRRD)	0	0	0	0	0	0	0	0	00H	TBD
203	Upper nibble for tFAW	0	0	0	0	0	0	0	0	00H	TBD
204	Minimum four activate window delay time (tFAW)	0	0	0	0	0	0	0	0	00H	TBD
205	SDRAM minimum internal write to read command delay (tWTR)	0	0	0	0	0	0	0	0	00H	TBD
206	Write to read & read to write command turn-around time pull-in	0	0	0	0	0	0	0	0	00H	TBD
207	Back to back command turn-around time pull-in	0	0	0	0	0	0	0	0	00H	TBD
208	System address/ command rate (1N or 2N mode)	0	0	0	0	0	0	0	0	00H	TBD
209	Auto self-refresh performance (sub 1x refresh and IDD6 impacts)	0	0	0	0	0	0	0	0	00H	TBD
210 to 218	Reserved	0	0	0	0	0	0	0	0	00H	
219	Vendor personality byte	0	0	0	0	0	0	0	0	00H	

[For Profile 2]

Byte No.	Function described	Bit7	Bit6	Bit5	Bit4	Bit3	Bit2	Bit1	Bit0	Hex value	Comments
220	Module VDD voltage level (extreme settings)	0	0	0	0	0	0	0	0	00H	TBD
221	SDRAM minimum cycle time (tCK (min))	0	0	0	0	0	0	0	0	00H	TBD
222	Minimum CAS latency time (tAA (min))	0	0	0	0	0	0	0	0	00H	TBD
223	SDRAM /CAS latencies supported, LSB (CL MASK)	0	0	0	0	0	0	0	0	00H	TBD
224	SDRAM /CAS latencies supported, MSB (CL MASK)	0	0	0	0	0	0	0	0	00H	
225	Minimum CAS write latency time (tCWL (min))	0	0	0	0	0	0	0	0	00H	TBD
226	SDRAM minimum row precharge time (tRP)	0	0	0	0	0	0	0	0	00H	TBD
227	SDRAM minimum /RAS to /CAS delay (tRCD)	0	0	0	0	0	0	0	0	00H	TBD
228	SDRAM write recovery time (tWR (min))	0	0	0	0	0	0	0	0	00H	TBD
229	SDRAM upper nibbles for tRAS and tRC	0	0	0	0	0	0	0	0	00H	TBD
230	SDRAM minimum active to precharge time (tRAS), LSB	0	0	0	0	0	0	0	0	00H	TBD
231	SDRAM minimum active to active /auto-refresh time (tRC), LSB	0	0	0	0	0	0	0	0	00H	TBD
232	Maximum average periodic refresh interval (tREFI), LSB	0	0	0	0	0	0	0	0	00H	TBD
233	Maximum average periodic refresh interval (tREFI), MSB	0	0	0	0	0	0	0	0	00H	TBD
234	SDRAM minimum refresh recovery time delay (tRFC), LSB	0	0	0	0	0	0	0	0	00H	TBD
235	SDRAM minimum refresh recovery time delay (tRFC), MSB	0	0	0	0	0	0	0	0	00H	TBD
236	SDRAM minimum internal read to precharge command delay (tRTP)	0	0	0	0	0	0	0	0	00H	TBD
237	SDRAM minimum row active to row active delay (tRRD)	0	0	0	0	0	0	0	0	00H	TBD

Byte No.	Function described	Bit7	Bit6	Bit5	Bit4	Bit3	Bit2	Bit1	Bit0	Hex value	Comments
238	Upper nibble for tFAW	0	0	0	0	0	0	0	0	00H	TBD
239	Minimum four activate window delay time (tFAW)	0	0	0	0	0	0	0	0	00H	TBD
240	SDRAM minimum internal write to read command delay (tWTR)	0	0	0	0	0	0	0	0	00H	TBD
241	Write to read & read to write command turn-around time pull-in	0	0	0	0	0	0	0	0	00H	TBD
242	Back to back command turn-around time pull-in	0	0	0	0	0	0	0	0	00H	TBD
243	System address/ command rate (1N or 2N mode)	0	0	0	0	0	0	0	0	00H	TBD
244	Auto self-refresh performance (sub 1x refresh and IDD6 impacts)	0	0	0	0	0	0	0	0	00H	TBD
245 to 253	Reserved	0	0	0	0	0	0	0	0	00H	
254	Vendor personality byte	0	0	0	0	0	0	0	0	00H	

Block Diagram

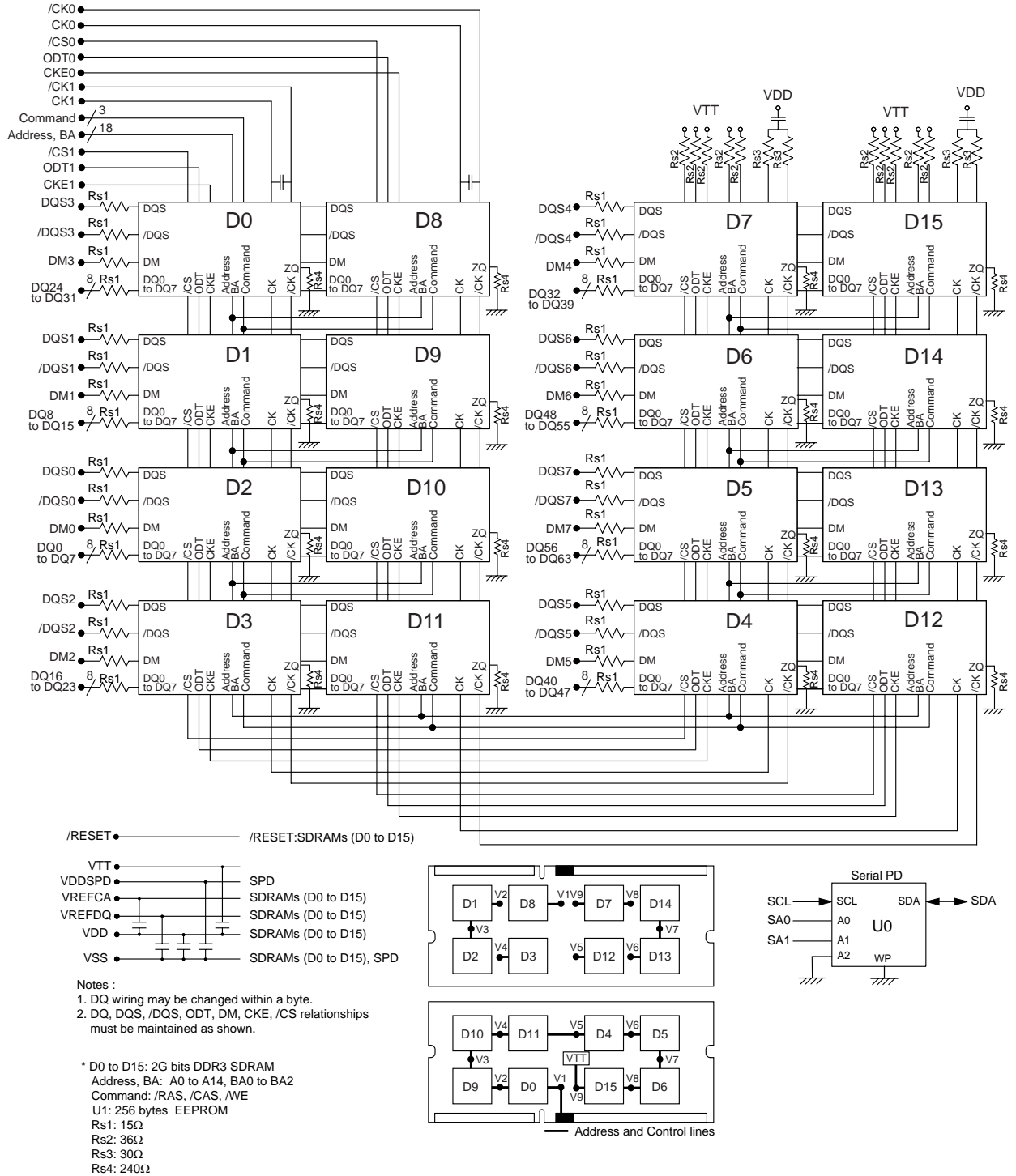

Electrical Specifications

- All voltages are referenced to VSS (GND).

Absolute Maximum Ratings

Parameter	Symbol	Value	Unit	Notes
Power supply voltage	VDD	-0.4 to +1.975	V	1, 3, 4
Input voltage	VIN	-0.4 to +1.975	V	1, 4
Output voltage	VOUT	-0.4 to +1.975	V	1, 4
Reference voltage	VREFCA	-0.4 to $0.6 \times VDD$	V	3, 4
Reference voltage for DQ	VREFDQ	-0.4 to $0.6 \times VDDQ$	V	3, 4
Storage temperature	Tstg	-55 to +100	°C	1, 2, 4
Power dissipation	PD	8	W	
Short circuit output current	IOUT	50	mA	1, 4

Notes: 1. Stresses greater than those listed under Absolute Maximum Ratings may cause permanent damage to the device. This is a stress rating only and functional operation of the device at these or any other conditions above those indicated in the operational sections of this specification is not implied. Exposure to absolute maximum rating conditions for extended periods may affect reliability.

2. Storage temperature is the case surface temperature on the center/top side of the DRAM.
3. VDD and VDDQ must be within 300mV of each other at all times; and VREF must be not greater than $0.6 \times VDDQ$, When VDD and VDDQ are less than 500mV; VREF may be equal to or less than 300mV.
4. DDR3 SDRAM component specification.

Caution Exposing the device to stress above those listed in Absolute Maximum Ratings could cause permanent damage. The device is not meant to be operated under conditions outside the limits described in the operational section of this specification Exposure to Absolute Maximum Rating conditions for extended periods may affect device reliability.

Operating Temperature Condition

Parameter	Symbol	Rating	Unit	Notes
Operating case temperature	TC	0 to +95	°C	1, 2, 3

Notes: 1. Operating temperature is the case surface temperature on the center/top side of the DRAM.

2. The Normal Temperature Range specifies the temperatures where all DRAM specifications will be supported. During operation, the DRAM case temperature must be maintained between 0°C to +85°C under all operating conditions.
3. Some applications require operation of the DRAM in the Extended Temperature Range between +85°C and +95°C case temperature. Full specifications are guaranteed in this range, but the following additional conditions apply:
 - a) Refresh commands must be doubled in frequency, therefore reducing the refresh interval tREFI to 3.9µs. (This double refresh requirement may not apply for some devices.)
 - b) If Self-refresh operation is required in the Extended Temperature Range, then it is mandatory to either use the Manual Self-Refresh mode with Extended Temperature Range capability (MR2 bit [A6, A7] = [0, 1]) or enable the optional Auto Self-Refresh mode (MR2 bit [A6, A7] = [1, 0]).

Recommended DC Operating Conditions (TC = 0°C to +85°C)

Parameter	Symbol	min.	typ.	max.	Unit	Notes
Supply voltage	VDD, VDDQ	1.425	1.5	1.575	V	1, 2, 3
	VSS	0	0	0	V	1
	VDDSPD	3.0	3.3	3.6	V	
Input reference voltage	VREFCA (DC)	$0.49 \times VDDQ$	$0.50 \times VDDQ$	$0.51 \times VDDQ$	V	1, 4, 5
Input reference voltage for DQ	VREFDQ (DC)	$0.49 \times VDDQ$	$0.50 \times VDDQ$	$0.51 \times VDDQ$	V	1, 4, 5
Termination voltage	VTT	$VDDQ/2 - TBD$	TBD	$VDDQ/2 + TBD$	V	

Notes: 1. DDR3 SDRAM component specification.

2. Under all conditions VDDQ must be less than or equal to VDD.

3. VDDQ tracks with VDD. AC parameters are measured with VDD and VDDQ tied together.

4. The AC peak noise on VREF may not allow VREF to deviate from VREF(DC) by more than $\pm 1\%$ VDD (for reference: approx ± 15 mV).

5. For reference: approx. $VDD/2 \pm 15$ mV.

DC Characteristics 1 (TC = 0°C to +85°C, VDD = 1.5V ± 0.075V, VSS = 0V)

Parameter	Symbol	Data rate (Mbps)	max.	Unit	Notes	
Operating current (ACT-PRE) (Another rank is in IDD2P1)	IDD0	1600	TBD	mA		
		1333	880			
		1066	800			
Operating current (ACT-PRE) (Another rank is in IDD3N)	IDD0	1600	TBD	mA		
		1333	1080			
		1066	856			
Operating current (ACT-READ-PRE) (Another rank is in IDD2P1)	IDD1	1600	TBD	mA		
		1333	1000			
		1066	920			
Operating current (ACT-READ-PRE) (Another rank is in IDD3N)	IDD1	1600	TBD	mA		
		1333	1200			
		1066	976			
	Precharge power-down standby current	IDD2P1	1600	TBD	mA	Fast PD Exit
			1333	560		
			1066	480		
Precharge power-down standby current	IDD2P0	1600	TBD	mA	Slow PD Exit	
		1333	240			
		1066	240			
Precharge standby current	IDD2N	1600	TBD	mA		
		1333	720			
		1066	720			
Precharge standby ODT current	IDD2NT	1600	TBD	mA		
		1333	720			
		1066	720			
Precharge quiet standby current	IDD2Q	1600	TBD	mA		
		1333	720			
		1066	640			
Active power-down current (Always fast exit)	IDD3P	1600	TBD	mA		
		1333	592			
		1066	592			
Active standby current	IDD3N	1600	TBD	mA		
		1333	960			
		1066	880			
Operating current (Burst read operating) (Another rank is in IDD2P1)	IDD4R	1600	TBD	mA		
		1333	1520			
		1066	1320			
Operating current (Burst read operating) (Another rank is in IDD3N)	IDD4R	1600	TBD	mA		
		1333	1720			
		1066	1520			
Operating current (Burst write operating) (Another rank is in IDD2P1)	IDD4W	1600	TBD	mA		
		1333	1560			
		1066	1360			
Operating current (Burst write operating) (Another rank is in IDD3N)	IDD4W	1600	TBD	mA		
		1333	1760			
		1066	1560			
Burst refresh current (Another rank is in IDD2P1)	IDD5B	1600	TBD	mA		
		1333	2440			
		1066	2360			
Burst refresh current (Another rank is in IDD3N)	IDD5B	1600	TBD	mA		
		1333	2640			
		1066	2560			
All bank interleave read current (Another rank is in IDD2P1)	IDD7	1600	TBD	mA		
		1333	2520			
		1066	2080			
All bank interleave read current (Another rank is in IDD3N)	IDD7	1600	TBD	mA		
		1333	2720			
		1066	2280			

Self-Refresh Current (TC = 0°C to +85°C, VDD = 1.5V ± 0.075V)

Parameter	Symbol	max.	Unit	Notes
Self-refresh current normal temperature range	IDD6	272	mA	
Self-refresh current extended temperature range	IDD6ET	352	mA	
Auto self-refresh current (optional)	IDD6TC	—	mA	

Timings used for IDD and IDDQ Measurement-Loop Patterns

Parameter	DDR3-1600	DDR3-1333	DDR3-1066	Unit
	11-11-11	9-9-9	7-7-7	
CL	TBD	9	7	nCK
tCK min.	TBD	1.5	1.875	ns
nRCD min.	TBD	9	7	nCK
nRC min.	TBD	33	27	nCK
nRAS min.	TBD	24	20	nCK
nRP min.	TBD	9	7	nCK
nFAW	TBD	20	20	nCK
nRRD	TBD	4	4	nCK
nRFC	TBD	107	86	nCK

Pin Functions

CK, /CK (input pin)

CK and /CK are differential clock inputs. All address and control input signals are sampled on the crossing of the positive edge of CK and negative edge of /CK. Output (read) data is referenced to the crossings of CK and /CK (both directions of crossing).

/CS (input pin)

All commands are masked when /CS is registered high. /CS provides for external rank selection on systems with multiple ranks. /CS is considered part of the command code.

/RAS, /CAS, and /WE (input pins)

/RAS, /CAS and /WE (along with /CS) define the command being entered.

A0 to A14 (input pins)

Provided the row address for active commands and the column address for read/write commands to select one location out of the memory array in the respective bank. (A10(AP) and A12(/BC) have additional functions, see below) The address inputs also provide the op-code during mode register set commands.

[Address Pins Table]

Address (A0 to A14)

Row address (RA)	Column address (CA)	Notes
AX0 to AX14	AY0 to AY9	

A10(AP) (input pin)

A10 is sampled during read/write commands to determine whether auto-precharge should be performed to the accessed bank after the read/write operation. (high: auto-precharge; low: no auto-precharge)

A10 is sampled during a precharge command to determine whether the precharge applies to one bank (A10 = low) or all banks (A10 = high). If only one bank is to be precharged, the bank is selected by bank addresses (BA).

A12 (/BC) (input pin)

A12 is sampled during read and write commands to determine if burst chop (on-the-fly) will be performed.

(A12 = high: no burst chop, A12 = low: burst chopped.)

BA0 to BA2 (input pins)

BA0, BA1 and BA2 define to which bank an active, read, write or precharge command is being applied. BA0 and BA1 also determine if a mode register is to be accessed during a MRS cycle.

[Bank Select Signal Table]

	BA0	BA1	BA2
Bank 0	L	L	L
Bank 1	H	L	L
Bank 2	L	H	L
Bank 3	H	H	L
Bank 4	L	L	H
Bank 5	H	L	H
Bank 6	L	H	H
Bank 7	H	H	H

Remark: H: VIH. L: VIL.

CKE (input pin)

CKE high activates, and CKE low deactivates, internal clock signals and device input buffers and output drivers. Taking CKE low provides precharge power-down and self-refresh operation (all banks idle), or active power-down (row active in any bank). CKE is asynchronous for self-refresh exit. After VREF has become stable during the power-on and initialization sequence, it must be maintained for proper operation of the CKE receiver. For proper self-refresh entry and exit, VREF must be maintained to this input. CKE must be maintained high throughout read and write accesses. Input buffers, excluding CK, /CK, ODT and CKE are disabled during power-down. Input buffers, excluding CKE, are disabled during self-refresh.

DQ (input and output pins)

Bi-directional data bus.

DQS and /DQS (input and output pin)

Output with read data, input with write data. Edge-aligned with read data, centered in write data. The data strobe DQS is paired with differential signals /DQS to provide differential pair signaling to the system during READs and WRITEs.

ODT (input pins)

ODT (registered high) enables termination resistance internal to the DDR3 SDRAM. When enabled, ODT is only applied to each DQ, DQS, /DQS, DM. The ODT pin will be ignored if the mode register (MR1) is programmed to disable ODT.

DM (input pins)

DM is the reference signal of the data input mask function. DMs are sampled at the cross point of DQS and /DQS.

VDD (power supply pins)

1.5V is applied. (VDD is for the internal circuit.)

VDDSPD (power supply pin)

3.3V is applied (For serial EEPROM).

VSS (power supply pin)

Ground is connected.

VTT (power supply pin)

I/O termination supply for SDRAM.

VREFDQ (power supply)

Reference voltage for DQ.

VREFCA (power supply)

Reference voltage for CA.

/RESET (input pin)

/RESET is negative active signal (active low) and is referred to GND.

Detailed Operation Part, Electrical Characteristics and Timing Waveforms

Refer to the EDJ2104BASE, EDJ2108BASE datasheet (E1505E).

Physical Outline

Unit: mm

Front side

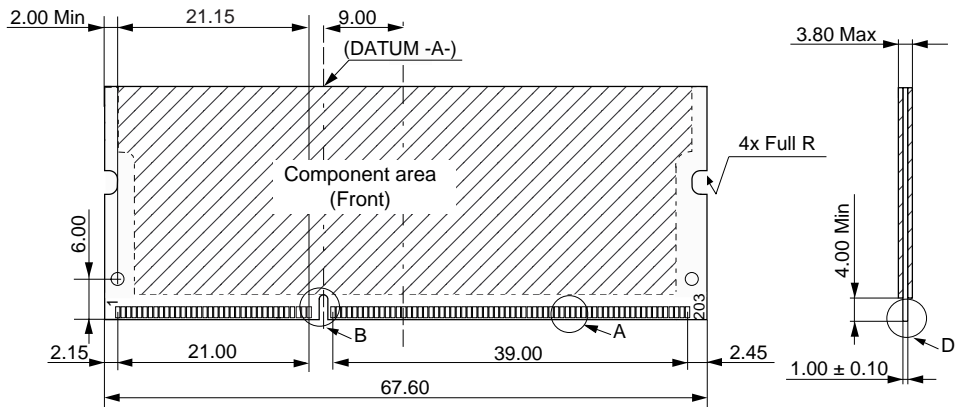

Back side

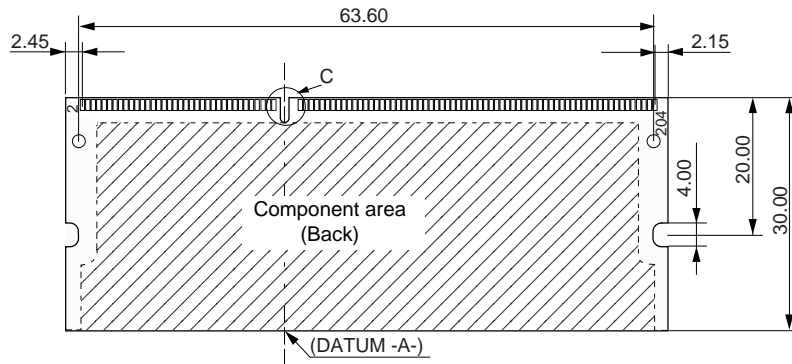

Detail A

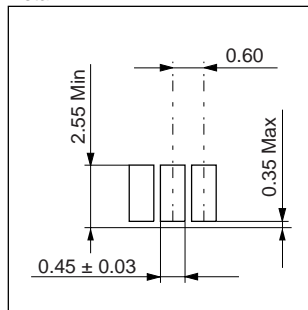

Detail B

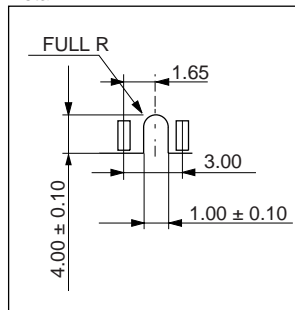

Detail C

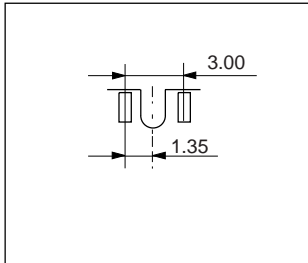

Detail D

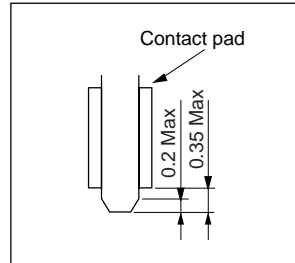

ECA-TS2-0215-01

CAUTION FOR HANDLING MEMORY MODULES

When handling or inserting memory modules, be sure not to touch any components on the modules, such as the memory ICs, chip capacitors and chip resistors. It is necessary to avoid undue mechanical stress on these components to prevent damaging them.

In particular, do not push module cover or drop the modules in order to protect from mechanical defects, which would be electrical defects.

When re-packing memory modules, be sure the modules are not touching each other.

Modules in contact with other modules may cause excessive mechanical stress, which may damage the modules.

MDE0202

NOTES FOR CMOS DEVICES**① PRECAUTION AGAINST ESD FOR MOS DEVICES**

Exposing the MOS devices to a strong electric field can cause destruction of the gate oxide and ultimately degrade the MOS devices operation. Steps must be taken to stop generation of static electricity as much as possible, and quickly dissipate it, when once it has occurred. Environmental control must be adequate. When it is dry, humidifier should be used. It is recommended to avoid using insulators that easily build static electricity. MOS devices must be stored and transported in an anti-static container, static shielding bag or conductive material. All test and measurement tools including work bench and floor should be grounded. The operator should be grounded using wrist strap. MOS devices must not be touched with bare hands. Similar precautions need to be taken for PW boards with semiconductor MOS devices on it.

② HANDLING OF UNUSED INPUT PINS FOR CMOS DEVICES

No connection for CMOS devices input pins can be a cause of malfunction. If no connection is provided to the input pins, it is possible that an internal input level may be generated due to noise, etc., hence causing malfunction. CMOS devices behave differently than Bipolar or NMOS devices. Input levels of CMOS devices must be fixed high or low by using a pull-up or pull-down circuitry. Each unused pin should be connected to V_{DD} or GND with a resistor, if it is considered to have a possibility of being an output pin. The unused pins must be handled in accordance with the related specifications.

③ STATUS BEFORE INITIALIZATION OF MOS DEVICES

Power-on does not necessarily define initial status of MOS devices. Production process of MOS does not define the initial operation status of the device. Immediately after the power source is turned ON, the MOS devices with reset function have not yet been initialized. Hence, power-on does not guarantee output pin levels, I/O settings or contents of registers. MOS devices are not initialized until the reset signal is received. Reset operation must be executed immediately after power-on for MOS devices having reset function.

CME0107

The information in this document is subject to change without notice. Before using this document, confirm that this is the latest version.

No part of this document may be copied or reproduced in any form or by any means without the prior written consent of Elpida Memory, Inc.

Elpida Memory, Inc. does not assume any liability for infringement of any intellectual property rights (including but not limited to patents, copyrights, and circuit layout licenses) of Elpida Memory, Inc. or third parties by or arising from the use of the products or information listed in this document. No license, express, implied or otherwise, is granted under any patents, copyrights or other intellectual property rights of Elpida Memory, Inc. or others.

Descriptions of circuits, software and other related information in this document are provided for illustrative purposes in semiconductor product operation and application examples. The incorporation of these circuits, software and information in the design of the customer's equipment shall be done under the full responsibility of the customer. Elpida Memory, Inc. assumes no responsibility for any losses incurred by customers or third parties arising from the use of these circuits, software and information.

[Product applications]

Be aware that this product is for use in typical electronic equipment for general-purpose applications. Elpida Memory, Inc. makes every attempt to ensure that its products are of high quality and reliability. However, users are instructed to contact Elpida Memory's sales office before using the product in aerospace, aeronautics, nuclear power, combustion control, transportation, traffic, safety equipment, medical equipment for life support, or other such application in which especially high quality and reliability is demanded or where its failure or malfunction may directly threaten human life or cause risk of bodily injury.

[Product usage]

Design your application so that the product is used within the ranges and conditions guaranteed by Elpida Memory, Inc., including the maximum ratings, operating supply voltage range, heat radiation characteristics, installation conditions and other related characteristics. Elpida Memory, Inc. bears no responsibility for failure or damage when the product is used beyond the guaranteed ranges and conditions. Even within the guaranteed ranges and conditions, consider normally foreseeable failure rates or failure modes in semiconductor devices and employ systemic measures such as fail-safes, so that the equipment incorporating Elpida Memory, Inc. products does not cause bodily injury, fire or other consequential damage due to the operation of the Elpida Memory, Inc. product.

[Usage environment]

Usage in environments with special characteristics as listed below was not considered in the design. Accordingly, our company assumes no responsibility for loss of a customer or a third party when used in environments with the special characteristics listed below.

Example:

- 1) Usage in liquids, including water, oils, chemicals and organic solvents.
- 2) Usage in exposure to direct sunlight or the outdoors, or in dusty places.
- 3) Usage involving exposure to significant amounts of corrosive gas, including sea air, CL₂, H₂S, NH₃, SO₂, and NO_x.
- 4) Usage in environments with static electricity, or strong electromagnetic waves or radiation.
- 5) Usage in places where dew forms.
- 6) Usage in environments with mechanical vibration, impact, or stress.
- 7) Usage near heating elements, igniters, or flammable items.

If you export the products or technology described in this document that are controlled by the Foreign Exchange and Foreign Trade Law of Japan, you must follow the necessary procedures in accordance with the relevant laws and regulations of Japan. Also, if you export products/technology controlled by U.S. export control regulations, or another country's export control laws or regulations, you must follow the necessary procedures in accordance with such laws or regulations.

If these products/technology are sold, leased, or transferred to a third party, or a third party is granted license to use these products, that third party must be made aware that they are responsible for compliance with the relevant laws and regulations.

M01E0706