

Part Number Decoder

This document is intended to give customers understanding of the Elpida part numbering system. For detailed line-up about the individual products, please consult Elpida sales representatives.

Elpida Products

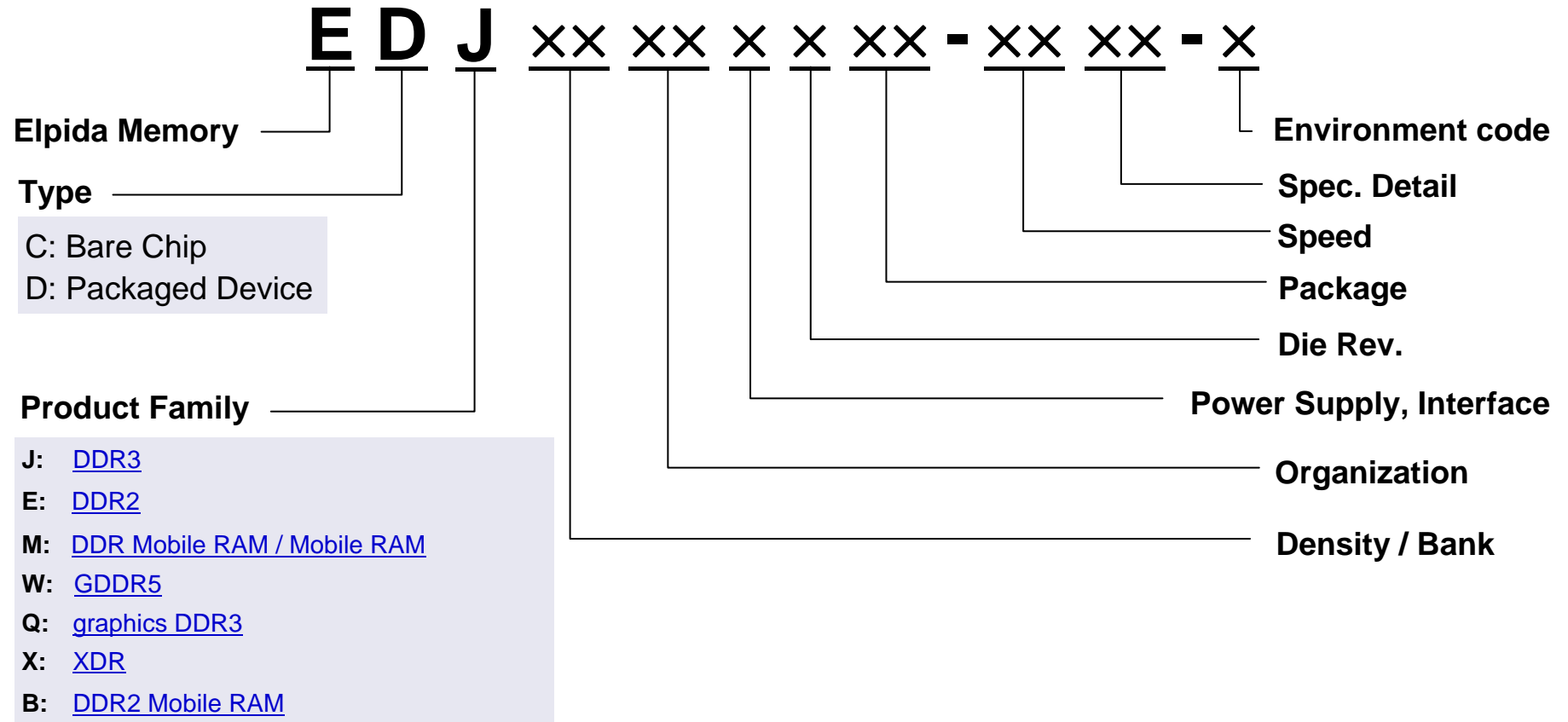

Elpida Products (Module)

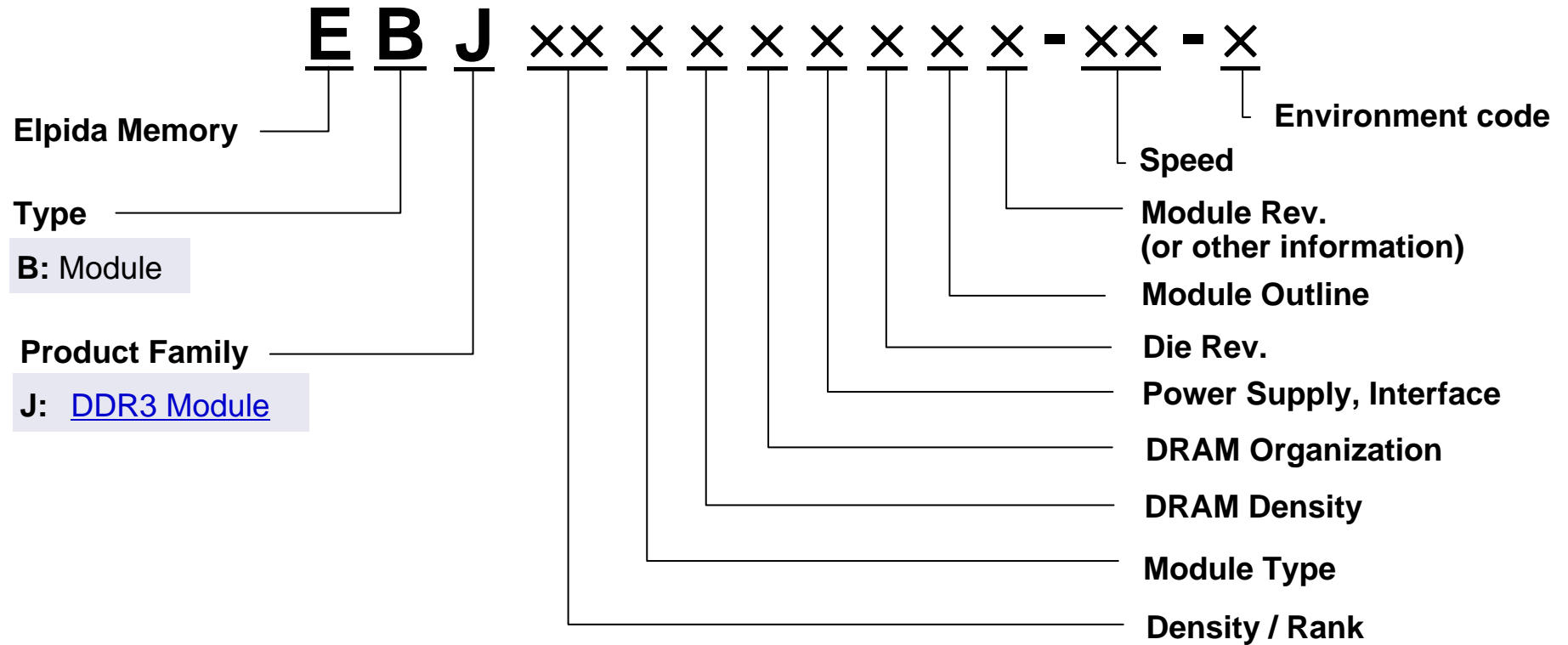

DDR3

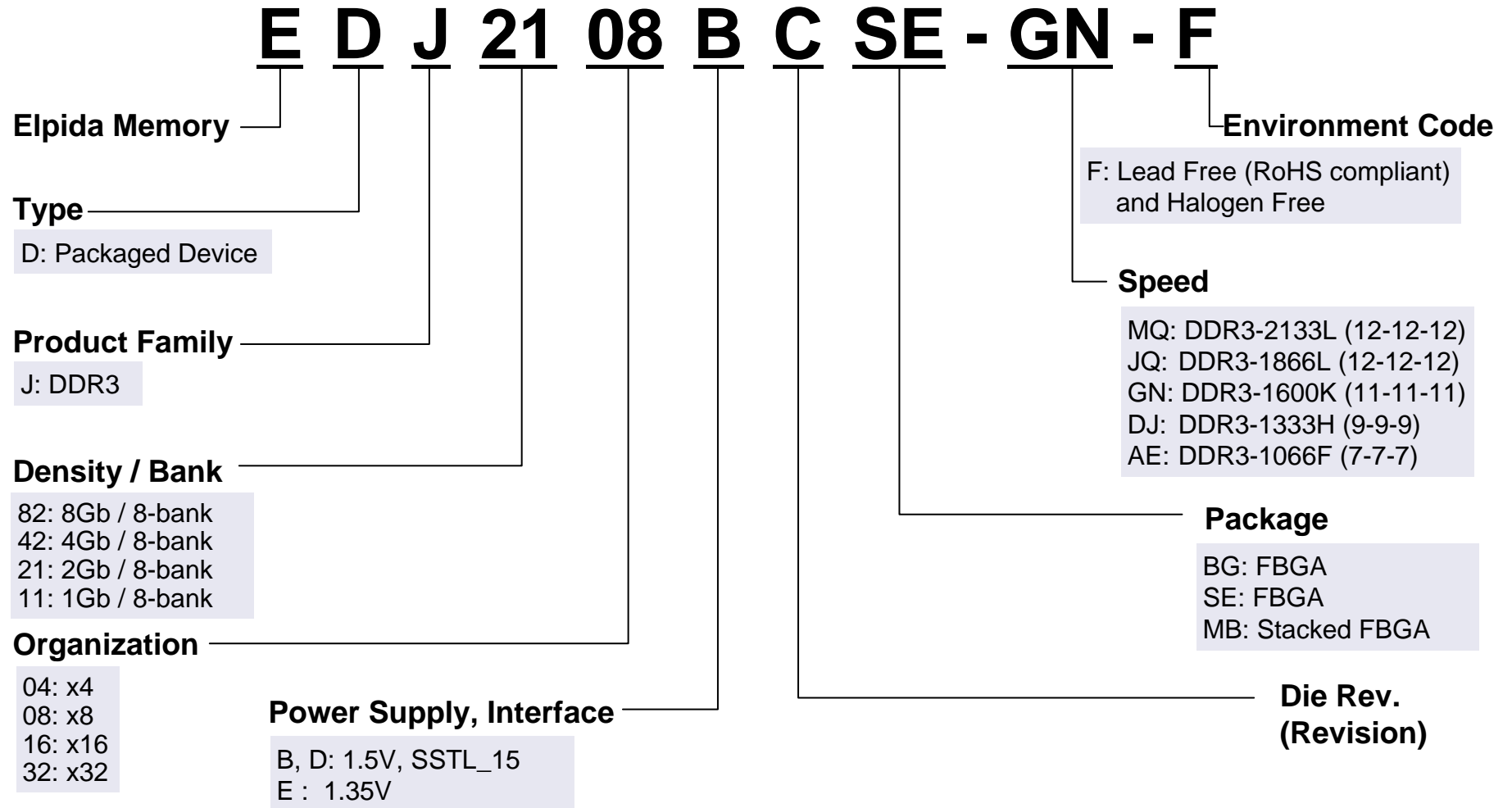

DDR3 Module

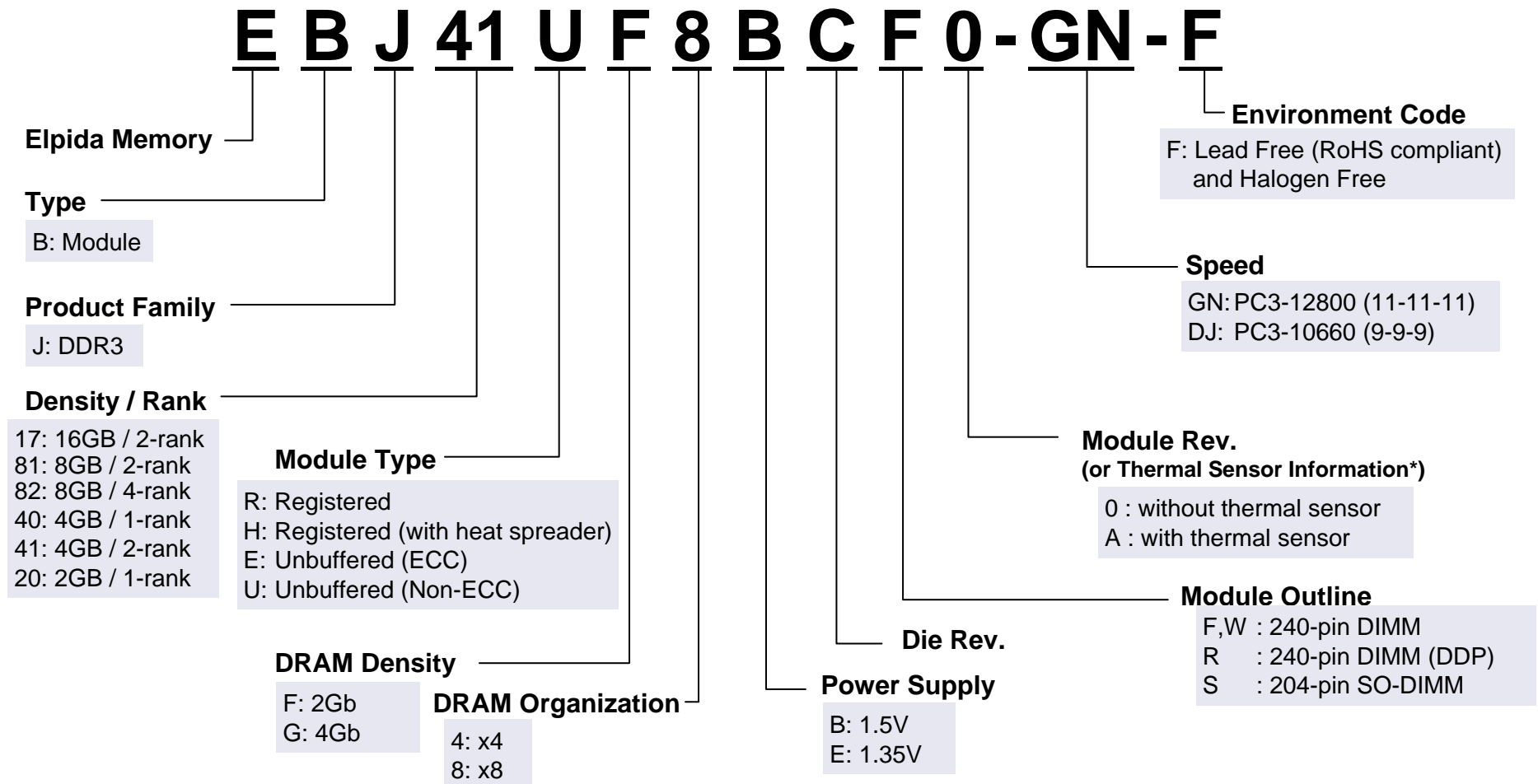

*: In case of unbuffered Non-ECC DIMM.
Both of "A" and "0" mean without thermal sensor.

DDR2

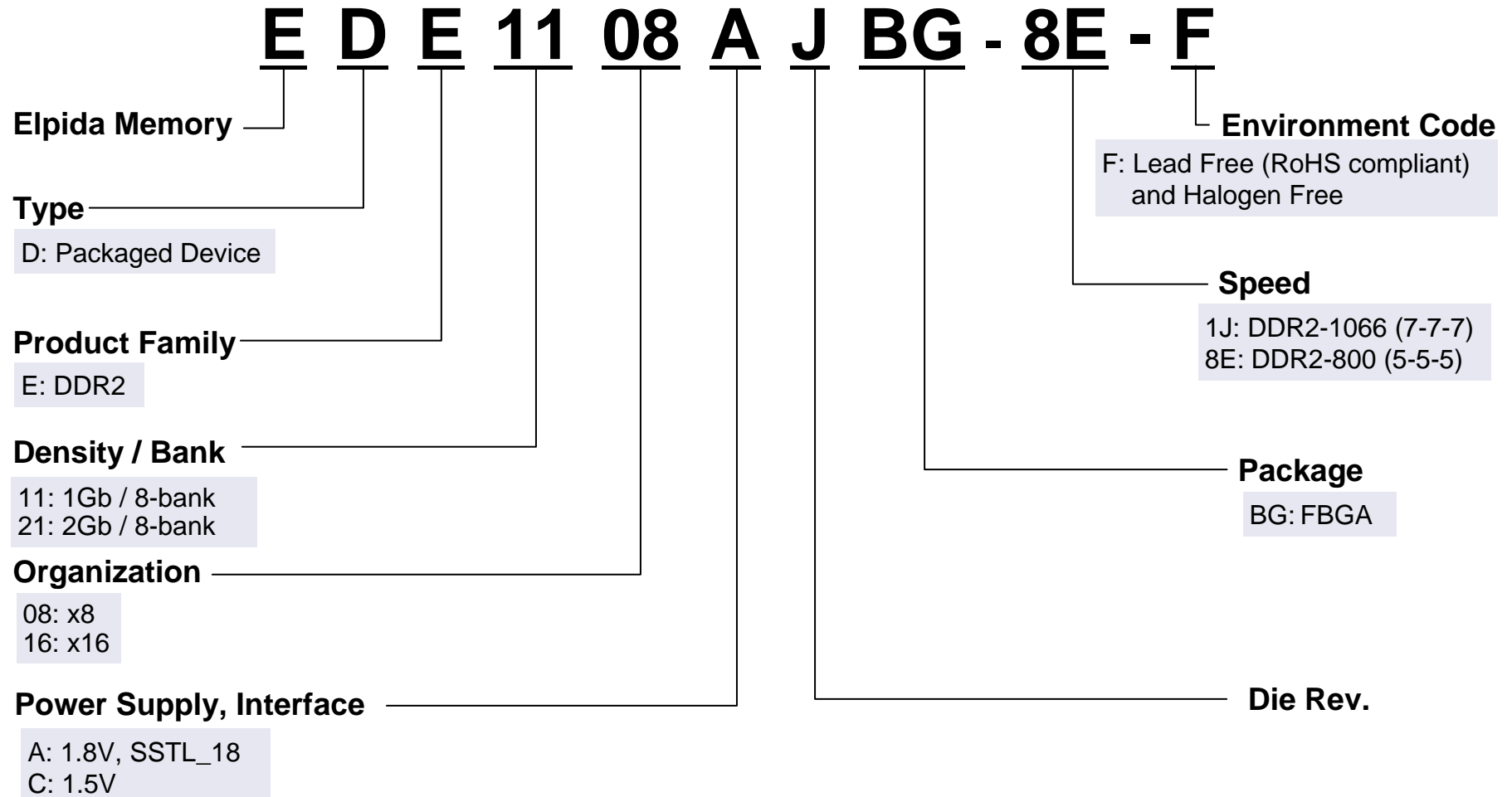

DDR2 Mobile RAM™ Bare Chip

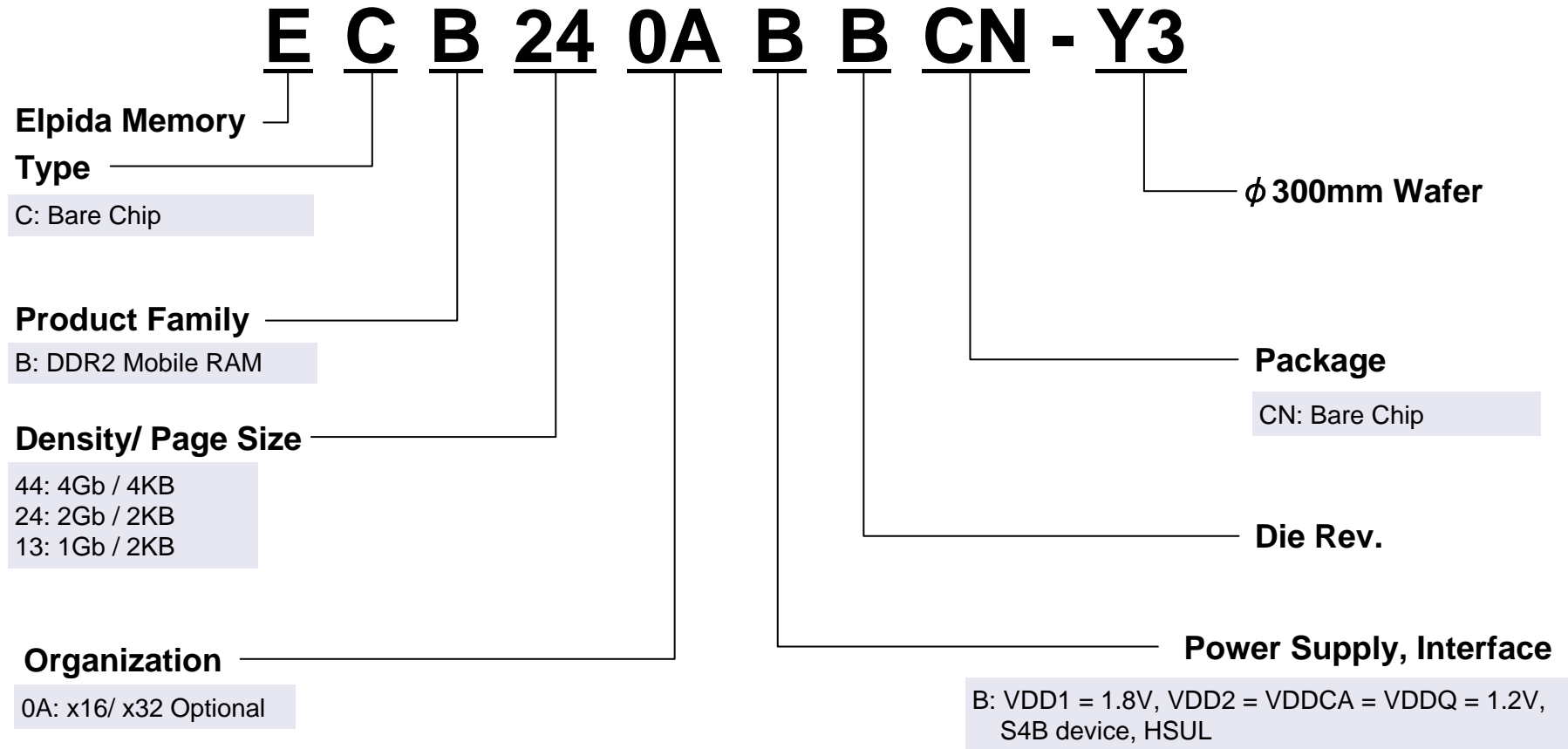

DDR Mobile RAM™ Bare Chip

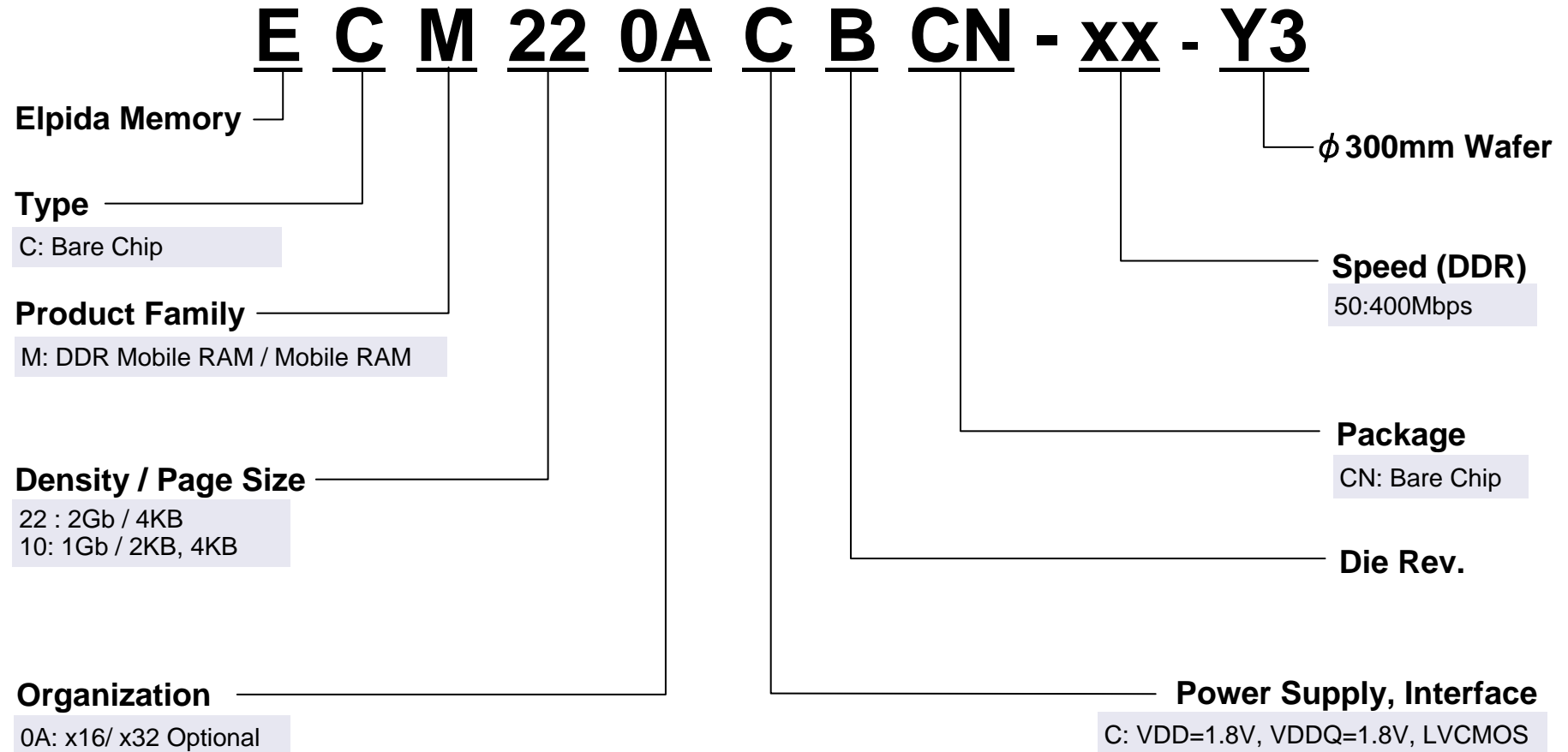

Graphics DRAM (GDDR5, graphics DDR3)

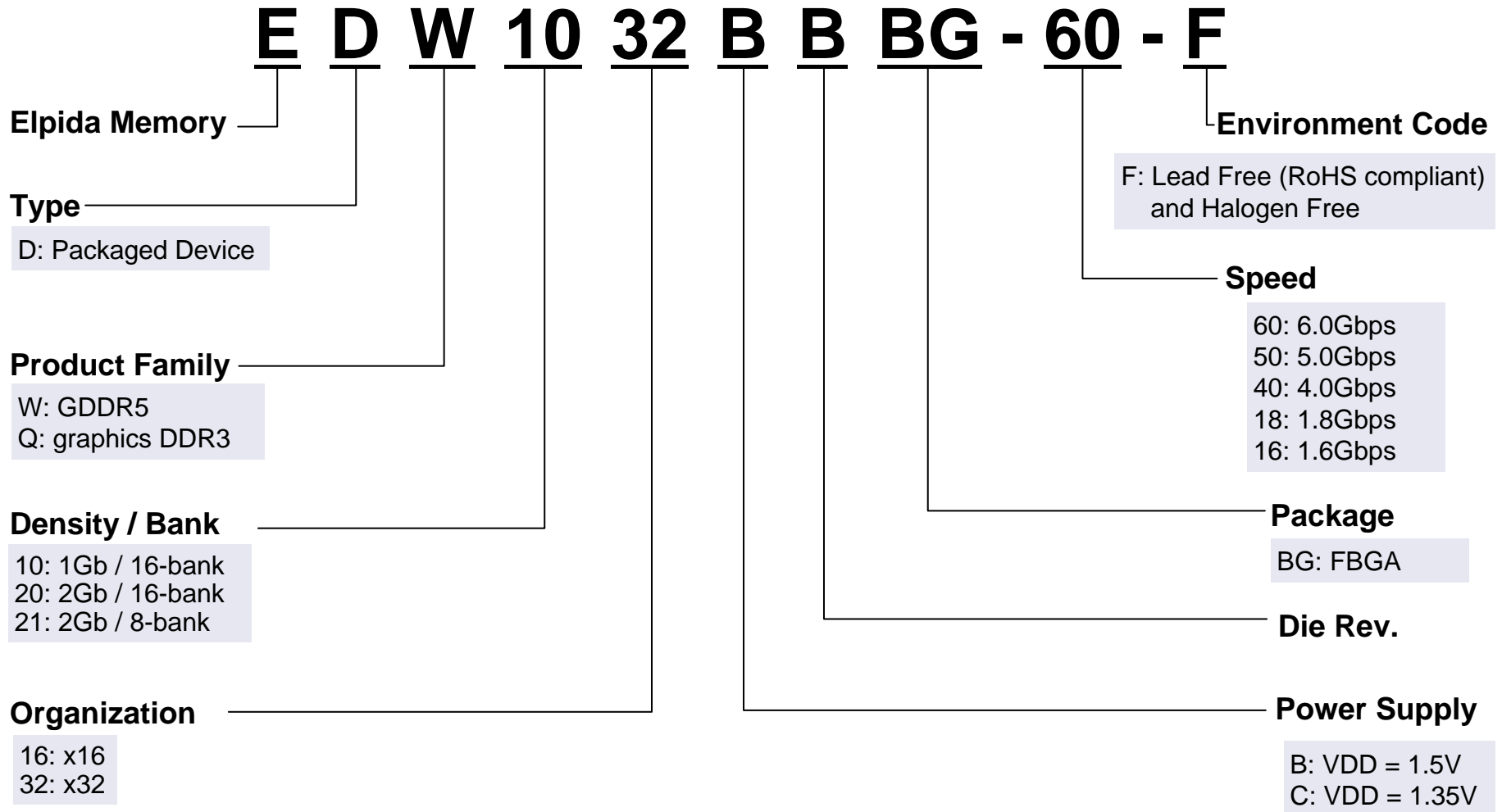

XDR™

